

FEATURES :

- *Ultra-wide Bandwidth*
- *Low Insertion Loss*
- *Tight phase and amplitude balance*

SPECIFICATIONS

Frequency Range, [MHz]	0.02 -3
Insertion Loss, typ/max [dB] (above 3dB Split Loss)	0.6 / 0.8
Isolation, min [dB]	30
Amplitude Balance, max [dB]	±0.3
Phase Balance, typ/max [degrees]	±1 / ±1.5
VSWR	1.3 : 1

Operating Characteristics

Input Power, max. [mW] with matched loads	1000
Impedance, [Ohm]	50
Operating Temperature	-20°C to +70°C

Ordering Information

Model No.	Package
HYB002-3-8-SMA	A5
HYB002-3-8-N	A3
HYB002-3-8-BNC	A3

Outline drawing(A5) dimensions in inches

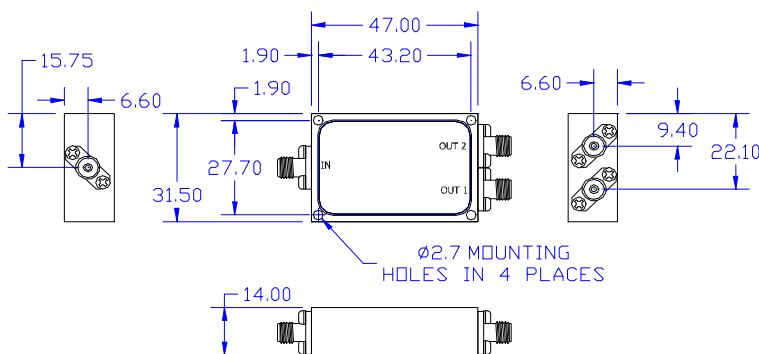

Typical Performance

