

**FEATURES :**

- *Ultra Wide Bandwidth*
- *Low Insertion Loss*
- *Tight Phase and Amplitude Balance*
- *Compact Size*

**SPECIFICATIONS**

Frequency Range, [MHz]	5 -2000
Insertion Loss*, typ/max [dB]	
10-1000MHz	0.9 / 1.0
5 - 2000MHz	1.5 / 2.2
Isolation, min [dB]	20
Amplitude Balance, typ/max [dB]	±0.4
Phase Balance, typ/max [degrees]	±6
VSWR, max 10-1500MHz	1.6:1
5 - 2000MHz	2.0:1

**Operating Characteristics**

Input Power CW max. [W], total as combiner, with matched loads	0.25
Input Power CW max. [W], as splitter with matched loads	1
Impedance, [Ohm]	50
Operating Temperature	-20°C to +70°C

**Ordering Information**

**Model No.**

**PD4-5-2000-SMA**

**Outline drawing**

dimensions in mm

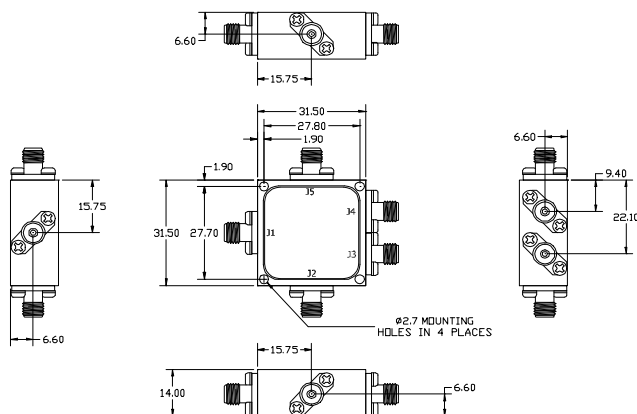

\* Above theoretical loss

Specifications Subject To Change Without Notice

**Typical Performance**

