

FEATURES :

- **Small Package**
- **High Q Response**
- **Low Loss Response**

SPECIFICATIONS

Center Frequency, [MHz]	1200
1dB Bandwidth, [MHz] min.	120
30dB Bandwidth, [MHz] max.	170
65dB Bandwidth, [MHz] max.	240
Insertion Loss@Center Freq. [dB]	0.6
VSWR	1.5 : 1
Average Power, [Watts]	25

Operating Characteristics

Operating Temperature	-40°C to+85°C
Impedance, [Ohm]	50

Ordering Information

Model No.	Connectors
FCL9-1200-120-SMA	SMA
FCL9-1200-120-N	N

Outline drawing

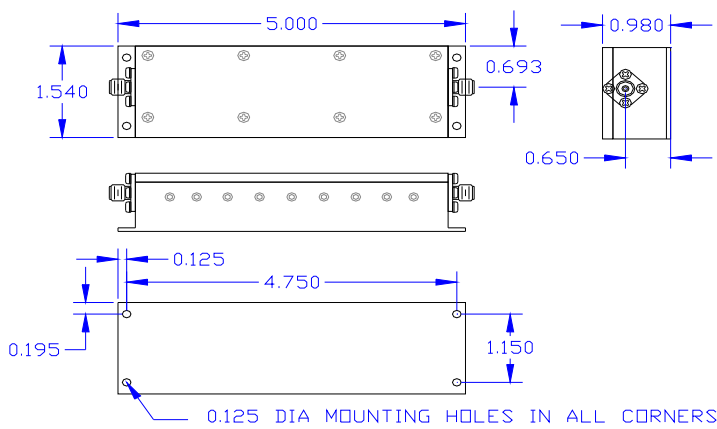

Dimensions in inches

Specifications Subject To Change Without Notice

Typical Performance

