

FEATURES :

- *Low Loss*
- *Small Size*
- *Wide Passband*

SPECIFICATIONS

3dB Corner Frequency, [MHz] typ.	15
Passband Frequency, MHz	20 to 3000
Passband Loss, [dB] max.	1.0
Stopband Frequency, MHz	DC to 2
Stopband Rejection, [dB] min.	80
VSWR	1.3 : 1

Operating Characteristics

Input Power, [W] with matched load	1
Impedance, [Ohm]	50
Connectors	SMA, N
Operating Temperature	-20°C to +70°C

Ordering Information

Model No.	Connectors
FHL5-20-SMA	SMA
FHL5-20-N	N

Outline drawing dimensions in mm

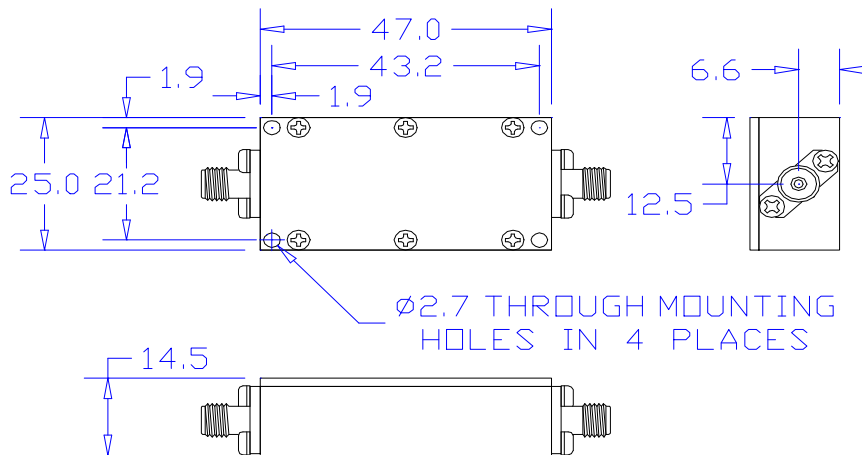

Typical Performance

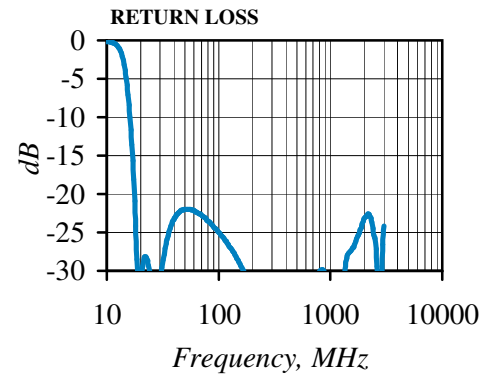
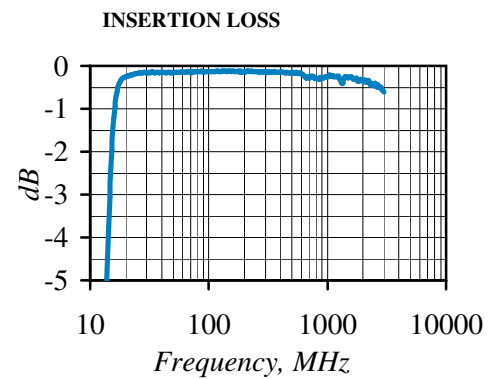
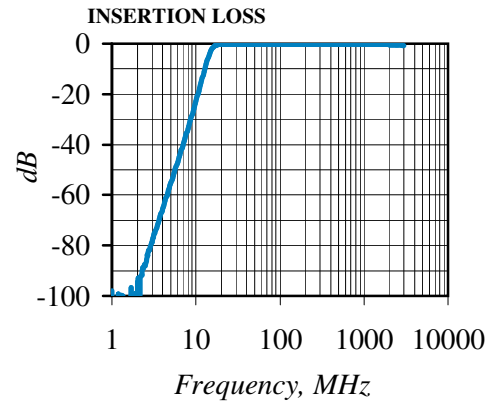

Specifications Subject To Change Without Notice