

FEATURES :

- Ultra low group delay variation
- Flat amplitude in passband
- Customized frequency and bandwidth options available

SPECIFICATIONS

Center Frequency, [MHz]	70
2.5dB Bandwidth, min [MHz]	10.8
7dB Bandwidth, max [MHz]	12.3
35dB Bandwidth, max [MHz]	18.24
Insertion Loss @ CF [dB]	10 ±1
Group Delay @ CF±4.32MHz [ns]	5
VSWR	1,3 : 1

Operating Characteristics

Operating Temperature	0°C to +70°C
Impedance, [Ohm]	75

Ordering Information

Model No.	Connectors
FLT/EQ-70-12-SMA	SMA
FLT/EQ-70-12-BNC	BNC

Outline drawing

Dimensions in inches

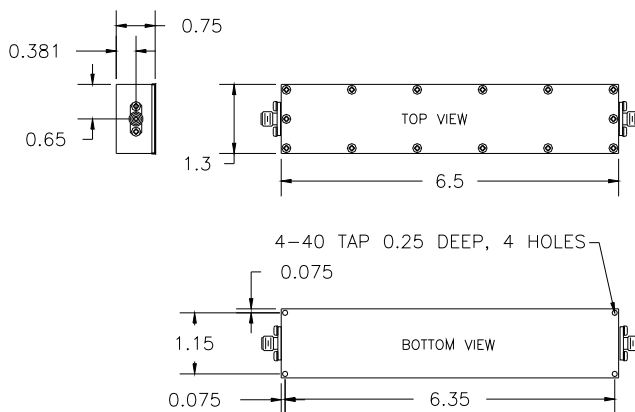

Typical Performance

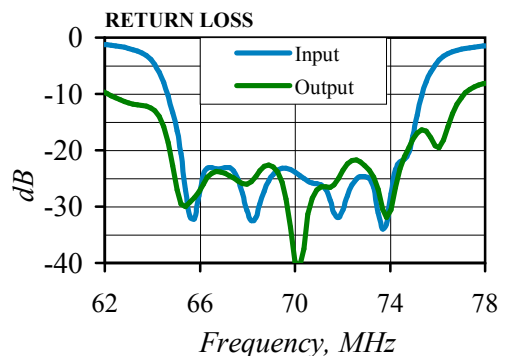
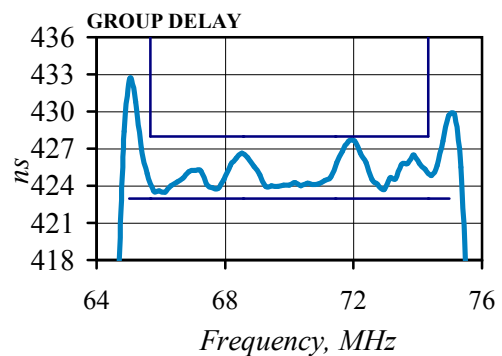
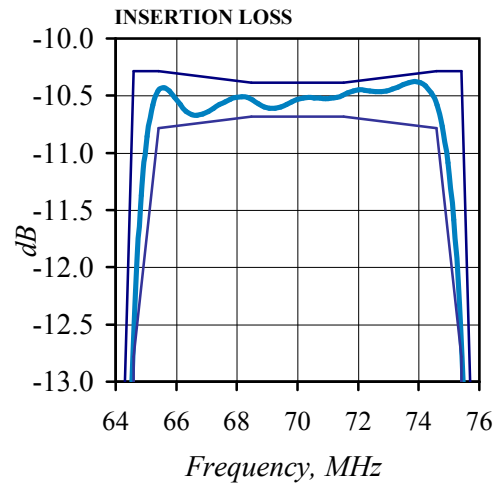
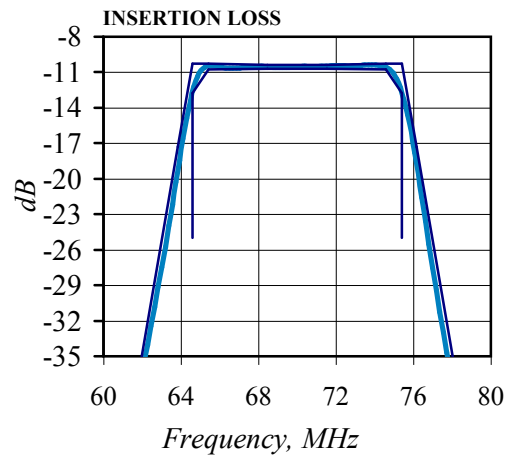

Specifications Subject To Change Without Notice